

# Table of Contents

1.	<b>Introduction to the Model 4017B</b>	2
1.1.	Description	2
1.2.	Feature Summary	2
2.	<b>Front panel</b>	2
2.1.	Brief description. Using the controls	2
2.2.	Buttons and knobs. LED functionality description	3
3.	<b>Operating the Model 4017B</b>	6
3.1.	<b>Parameter's setting</b>	6
3.1.1.	Frequency setting (except FREQCOUNTER mode)	6
3.1.2.	Level setting (except FREQCOUNTER mode)	8
3.1.3.	Offset setting (except FREQCOUNTER mode)	8
3.1.4.	Duty cycle setting (except FREQCOUNTER mode)	9
3.1.5.	CMOS level setting (except FREQCOUNTER mode)	9
3.1.6.	Sweep time setting (only for INTERNAL SWEEP mode)	9
3.1.7.	Sweep width setting (only for INTERNAL SWEEP mode)	10
3.1.8.	Gate setting (only for FREQCOUNTER mode)	10
3.2.	<b>Mode description</b>	10
3.2.1	<b>EXTERNAL VCG (External Voltage Control Generator)</b>	10
3.2.1.1	Selecting EXTERNAL VCG mode	12
3.2.1.2	Selecting output waveform	12
3.2.1.3	Selecting the frequency	12
3.2.1.4	Selecting the level	13
3.2.1.5	Selecting the offset	13
3.2.1.6	Selecting the duty cycle	13
3.2.1.7	Selecting output TTL/CMOS level	13
3.2.2	<b>INTERNAL SWEEP</b>	12
3.2.2.1	Selecting INTERNAL SWEEP mode	12
3.2.2.2	Selecting output waveform	12
3.2.2.3	Selecting the frequency	12
3.2.2.4	Selecting the level	13
3.2.2.5	Selecting the offset	13
3.2.2.6	Selecting the duty cycle	13
3.2.2.7	Selecting output TTL/CMOS level	13
3.2.2.8	Selecting sweep width	13
3.2.2.9	Selecting sweep time	13
3.2.2.10	Selecting type of sweeping	13
3.2.3	<b>FREQCOUNTER (Frequency Counter mode)</b>	13
3.2.3.1	Selecting FREQCOUNTER mode	14
3.2.3.2	Selecting gate period	14
3.2.4	<b>Saving the default loaded mode at power-up</b>	14
3.2.5	<b>Setting parameters examples</b>	14
3.2.5.1	Example of setting parameters in EXTERNAL VCG mode	14
3.2.5.2	Example of setting parameters in INTERNAL SWEEP mode	16
3.2.5.3	Example of setting gate period in FREQCOUNTER mode	19
3.2.5.4	Example of saving the default mode at power-up	19
3.2.5.5	Waveform examples	20
3.3	<b>Remote operation</b>	25
3.3.1	Brief command description	25
3.3.2	Commands description	25
3.3.2.1	General rules	25
3.3.2.2	Commands description	26
3.3.3	<b>Remote program examples</b>	34
3.3.3.1	Example of setting parameters in EXTERNAL VCG mode using REMOTE control mode	34
3.3.3.2	Example of setting parameters in INTERNAL SWEEP mode using REMOTE control mode	35
3.3.3.3	Example of setting parameters in FREQCOUNTER mode using REMOTE control mode	36
4	<b>Specifications</b>	37
5	<b>Service Information</b>	38
6	<b>CE Cert</b>	39

## 1. Introduction to the 4017B.

### 1.1 Description

The **B&K Precision Model 4017B** Sweep/Function Generator is the newest 40XX family member. The 4017B enhances the performance achieved by its successful predecessor, BK Precision Model 4017A Sweep/Function Generator. These performances are achieved by using direct digital waveform synthesis (DDS) techniques for generating high accuracy and precision frequencies. A high performance Digital Signal Processor (DSP) controls every aspect of the DDS system, and is used for precise generation and processing of waveforms. The 4017B has a vast number of applications in both analog and digital electronics, in the engineering, manufacturing, servicing, educational and hobbyist fields. This versatile signal source is capable of generating waveform (such as sine, triangle and square), pulse generation (through variable symmetry) and frequency sweep. Additionally, the instrument provides a built-in frequency counter.

The core of the function generator is a DSP, which is used to generate precision sine, square or triangle waveforms over 0.01Hz to 10MHz range. This encompasses subaudible, audio, ultrasonic and RF applications. The symmetry of the waveforms can be changed between 0% to 100% in 1% steps, converting the instrument to a pulse generator capable of generating rectangular waves or pulses, ramp or sawtooth waves and slued sine waves. An external voltage may be used to control operating frequency that can be changed using a ratio between 1:1 and 1:100. Frequency sweep can be adjusted by changing the rate and the time sweep, and also the manner in which frequency is changed, linear or logarithmic.

The B&K Precision Model 4017B has 3 jacks: 2 for output and 1 input. The **OUTPUT** jack is the main signal output. The **TTL/CMOS** jack is a **TTL/CMOS** compatible square wave output. The **VCG/SWEEP** jack is an input used for controlling the operating frequency and input to the frequency counter.

The 4017B is capable of supplying an output level of 20.0V<sub>pp</sub> with an offset voltage of  $\pm 10.0V_{pp}$  (unloaded) on the main signal output, the **OUTPUT** jack. The output impedance is 50 ohms; therefore the 50 ohm loaded output level is 10.0V<sub>pp</sub>, with an offset voltage capability of  $\pm 5.0 V_{pp}$ . The output level can be adjusted with a resolution of 1mV and 10mV, depending on the level range being worked on. The offset level can be adjusted with a resolution of 1mV.

The 4017B is capable of generating a **TTL/CMOS** compatible square wave on **TTL/CMOS** jack. The CMOS output level can be up to 14.0 V<sub>pp</sub> (unloaded).

On the **VCG/SWEEP** input jack, DC levels can be applied between 0V to 10.0V in order to change the output operating frequency with a ratio between 1:1 and 1:100. This jack is also used as a frequency counter input, for frequencies between 5Hz and 100MHz.

The front panel of the Model 4017B includes LCD display, buttons, "intelligent" knobs and an LED in order to operate the unit quick and easy. The "intelligent" knobs are one of the main features of this new model, which reduces the number of controls needed for changing the value of a parameter. The LCD display is a large 2-line 16 columns back lighted display.

The unit also features an **EIA-RS232** connector on the rear of the unit. This permits the user to remote control the 4070A using ASCII characters. No special hardware or protocols are needed; any dumb terminal or computer serial port can be used. The baud rate is fixed to 9600 BPS.

## 1.2 Feature Summary

### 2. Front panel.

#### 2.1 Brief description.

Located on the Front Panel is the LCD display, controls, power switch, connection jacks and LED (see the figure 2 for details). The LCD display is a backlit, 2-row 16-columns LCD display.

There are two kinds of controls: buttons and knobs.

All buttons are implemented as 1-parameter single function control, except the range buttons that have a second function. Pressing the range buttons (UP and DOWN buttons) twice at the same time will save the current working state as the default loaded state at power-up. Pressing any other buttons at the same time will have no effect upon the current working state. There are 2 kinds of buttons: one category has no LED's, the other category has LED's. Pressing one of the buttons from the first category will change the values on the LCD display.

The knobs are implemented as 3-parameter single function control, with "intelligent" control. The parameters defining a knob are: value, rotating direction, and rotating speed. The value identifies the parameter being changed. The rotating direction, clockwise or counter clockwise, determines whether the value of the parameter is increment or decrement respectively, by an amount of 1. The speed of rotation sets the position in the parameter's digits of the digit being modified. The "intelligent knob" implementation allows a very simple and intuitive way of changing parameter values and reducing the number of controls used.

## 2.2 Buttons and knobs. LED functional description.

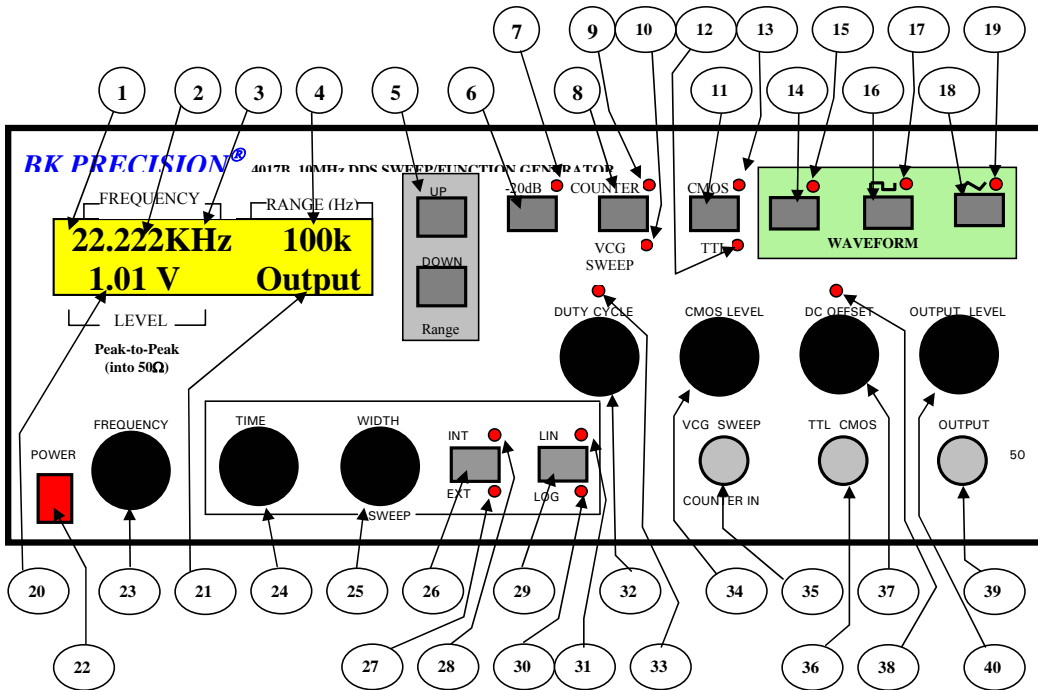

- 1 **LCD Display.** This is a 2 line X 16 columns LCD-large type display. The first line will always display the generated waveform frequency or the frequency measured sampling **COUNTER IN** input. The second line is used to display other parameters of the generated waveform, depending on the mode being worked: level, offset introduced, **TTL/CMOS** level, duty cycle when in **EXTERNAL VCG** mode, and additional parameters, time and width sweep when in **INTERNAL SWEEP** mode. In **FREQCOUNTER** mode on the second line, the gate used in sampling **COUNTER IN** input is displayed.
- 2 **Frequency field.** This field is used for displaying parameter frequency. The value displayed has a different meaning depending on the working mode. If in **EXTERNAL VCG** or **INTERNAL SWEEP**, the value represents the generated waveform frequency on the main output source, **OUTPUT** jack, and it is a 5-digit resolution value. If in **FREQCOUNTER** mode, the value represents the frequency of the signal sampled on **COUNTER IN** input, and can be a 9-digit resolution value.
- 3 **Frequency unit value.** This field will display the multiplying factor used for displaying frequency value. It changes when the user modifies the range using **“UP”** and **“DOWN”** buttons.
- 4 **Frequency range.** This field will display the range in which the frequency value displayed in *frequency field* can be changed. It changes when user modifies the range using **“UP”** and **“DOWN”** buttons.

- 5 **Range buttons.** Pressing those buttons will change the frequency range. Pressing the **UP and DOWN** buttons means that frequency range will change up and down, respectively. If reaching the upper or lower range by pressing the **UP or DOWN** buttons, it will pass to the lower range or upper range, respectively. Changing the range will affect the frequency field, frequency unit value and frequency range.
- By pressing these two buttons together twice, the current mode and parameters will be saved as the default power-up working state.
- 6 **-20 dB button.** Pressing this button will engage/disengage 20dB attenuation in the signal on **OUTPUT** jack. Pressing this button will change the level field. A light at - 20dB LED indicates engaging the attenuator. No light at -20dB LED indicates disengaging the attenuator.
- 7 **- 20 dB LED.** LED associated with the - 20 dB button has a solid light when the attenuator is active, and no light when attenuator is disabled.
- 8 **COUNTER/VCG SWEEP button.** Pressing this button will engage/disengage **FREQCOUNTER** mode. Engaging **FREQCOUNTER** mode will change the content of LCD display and will also be indicated by a lighted **COUNTER LED** only. Disengaging **FREQCOUNTER** mode will change the content of the LCD display and will also be indicated by a lighted **VCG SWEEP** LED only.
- 9 **COUNTER LED.** LED is associated with **COUNTER/VCG SWEEP** button that lights when **FREQCOUNTER** mode is active.
- 10 **VCG SWEEP LED.** LED is associated with **COUNTER/VCG SWEEP** button and lights when **EXTERNAL VCG** or **INTERNAL SWEEP** mode is active, and it is associated with a lighted EXT LED or INT LED respectively.
- 11 **TTL/CMOS button.** Pressing this button will enable/disable the use of CMOS LEVEL knob. If enabled, the CMOS LED is lighted and the output level on **TTL/CMOS** output jack can be changed. If disabled, the TTL LED is lighted and there will be a fixed level on **TTL/CMOS** output jack.
- 12 **TTL LED.** LED is associated with **TTL/CMOS** button, and lights when there is an output of a fixed TTL style signal on **TTL/CMOS** output jack.
- 13 **CMOS LED.** LED is associated with **TTL/CMOS** button and lights when there is an output of a variable CMOS style signal on **TTL/CMOS** output jack.
- 14 **SINE WAVE SELECT button.** Pressing this button will enable outputting of a sine style waveform on main output, **OUTPUT** jack, and will be indicated by a lighted **SINE WAVE LED**.
- 15 **SINE WAVE SELECT LED.** LED associated with **SINE WAVE SELECT** button, it lights when unit outputs a sine wave style signal on **OUTPUT** jack.
- 16 **SQUARE WAVE SELECT button.** Pressing this button will enable outputting of a square style waveform on main output, **OUTPUT** jack, and it will be indicated by a lighted **SQUARE WAVE SELECT LED**.
- 17 **SQUARE WAVE SELECT LED.** LED associated with **SQUARE WAVE SELECT** button, it lights when unit outputs a square wave style signal on **OUTPUT** jack.

- 18 **TRIANGLE WAVE SELECT button.** Pressing this button will enable outputting of a triangle style waveform on main output, **OUTPUT** jack, and it will be indicated by a lighted **TRIANGLE WAVE SELECT LED**.
- 19 **TRIANGLE WAVE SELECT LED.** LED associated with **TRIANGLE WAVE SELECT** button, it lights when unit outputs a triangle wave style signal on **OUTPUT** jack.
- 20 **OTHER PARAMETERS field.** This field is used for showing other parameters' values of the output signal on the **OUTPUT** jack such as level, offset, duty cycle, sweep time, sweep width or the CMOS output level on **TTL/CMOS** jack. As long as the value of a parameter during a 7-second period is not changed, the unit will automatically show the output level on the **OUTPUT** jack.
- 21 **OTHER PARAMETERS identifiers.** This field is associated with **OTHER PARAMETERS** field and will show a message relevant to the nature of the parameter value shown in **OTHER PARAMETERS** field. As long as the value of a parameter during a 7-second period is not changed, the unit will automatically display the message identifying the output level parameter.
- 22 **POWER switch.** Turns power on and off.
- 23 **FREQUENCY knob.** This knob controls the changing of the frequency within the current frequency range. The value is displayed in frequency field. The changes are applied upon the start frequency in **EXTERNAL VCG** and **INTERNAL SWEEP** mode. (See chapter **x** for a detailed explanation).  
This knob has no meaning in **FREQCOUNTER** mode.
- 24 **SWEEP TIME knob.** This knob controls the changing of the time value set for sweeping the range between start frequency and stop frequency. This knob has no meaning except **INTERNAL SWEEP** mode.
- 25 **SWEEP WIDTH knob.** This knob controls the changing of the ratio used for calculation of the width of frequency range, swept in **INTERNAL SWEEP** mode. This knob has no meaning except in **INTERNAL SWEEP** mode.
- 26 **SWEEP INT/EXT button.** Pressing this button will change the working mode between **EXTERNAL VCG** and **INTERNAL SWEEP**. The new mode will be indicated by the lighting of the corresponding LED, **INT LED** or **EXT LED**.
- 27 **EXT LED.** LED is associated to **SWEEP INT/EXT** button and lights when **EXTERNAL VCG** mode is active.
- 28 **INT LED.** LED is associated to **SWEEP INT/EXT** button and lights when **INTERNAL SWEEP** mode is active.
- 29 **SWEEP LIN/LOG button.** Pressing this button will change the way the frequency range in **INTERNAL SWEEP** mode will sweep between linear mode and logarithm mode. The lighting of the corresponding LED, **LIN LED** or **LOG LED** will indicate the working sweep mode. Button is valid only in **INTERNAL SWEEP** mode.
- 30 **LOG LED.** LED is associated to **SWEEP LIN/LOG** button and lights when logarithm sweep mode is engaged.
- 31 **LIN LED.** LED is associated to **SWEEP LIN/LOG** button and lights when linear sweep mode is engaged.
- 32 **DUTY CYCLE knob.** This knob controls the changing of the duty cycle of the output waveform on **OUTPUT** jack. It has meaning only for **EXTERNAL VCG** and **INTERNAL SWEEP**.

- 33 **DUTY CYCLE LED.** LED is associated with **DUTY CYCLE** knob and lights when the waveform is asymmetric.
- 34 **CMOS LEVEL knob.** This knob controls the changing of the CMOS level on the output of **TTL/CMOS** jack. This knob has meaning only for **EXTERNAL VCG** and **INTERNAL SWEEP**. It is only active if **TTL/CMOS** button enables it. The CMOS LED must be lit.
- 35 **VCG SWEEP/COUNTER IN jack.** Input jack is used to control the output frequency in **EXTERNAL VCG** mode or as frequency count input in **FREQCOUNTER** mode.
- 36 **TTL/CMOS jack.** Output jack is used for supplying a fixed TTL style signal or variable CMOS style signal, depending of the **TTL/CMOS** button, whose frequency is the same as the signal's frequency on the main output, **OUTPUT** jack.
- 37 **DC OFFSET knob.** This knob controls the offset level added to the signal outputted on the **OUTPUT** jack. It has an LED associated, **DC OFFSET LED**, which lights when the offset added is not zero. This knob has meaning only in **EXTERNAL VCG** and **INTERNAL SWEEP**.
- 38 **DC OFFSET LED.** LED associated with **DC OFFSET** knob, lights when the value of offset added to the signal on the **OUTPUT** jack is not zero.
- 39 **OUTPUT LEVEL knob.** This knob controls the output level on main output, **OUTPUT** jack. This knob has meaning only in **EXTERNAL VCG** and **INTERNAL SWEEP**.
- 40 **OUTPUT jack.** The main output jack, used to supply the desired waveform, defined by frequency, level, offset, duty cycle for **EXTERNAL VCG** mode and moreover time and width sweep for **INTERNAL SWEEP** mode.

### 3. Operating the Model 4017B.

There are 2 modes of controlling the unit and 3 modes of operating the unit. One of the control modes uses the front panel; the other mode is by remote, using the RS232 interface. Each mode of control excludes the other. When you are using the front panel you cannot control the unit by remote. Engaging remote mode, using special command, deactivates the use of front panel controls. Disengaging the remote control by using a special command enables the use of front panel button.

The 3 modes of operating are **EXTERNAL VCG** (external voltage control generator), **INTERNAL SWEEP** and **FREQCOUNTER** (frequency counter).

Section 3.1. - Mode description will describe the setting of operating modes using front panel controls. Section 3.2.-Remote operation, will have a complete description of the remote control mode.

#### 3.1. Parameter's setting

##### 3.1.1. Frequency setting (except FREQCOUNTER mode).

The frequency setting depends on the mode being worked. On **EXTERNAL VCG** mode, output frequency depends on the value set by turning the **FREQUENCY** knob and the DC value applied to **VCG/SWEEP** input jack. On **INTERNAL SWEEP** mode, since frequency is sweeping a range, the value set by turning the **FREQUENCY** knob represents the start frequency of the range being swept.

For all modes (except **FREQCOUNTER** mode), frequency is displayed on the first line, using a 5-digit field and a decimal point, whose position depends on the selected range. The unit is displayed after the frequency value field. The frequency range used is always displayed on the right of the first line.

There are 5 frequency ranges available, which allows the user to set desired frequency between 0.00Hz and 10.000MHz. Pressing **UP** and **DOWN** buttons will change the range. Within every range the frequency can be changed with a 5-digit resolution using **FREQUENCY** knob.

The table below shows the frequency limits for every range, measuring unit and how it displays the frequency range:

Range	Lower Value	Upper Value	Unit	Displayed frequency range
1	0.00	999.99	Hz	1k
2	1.0000	9.9999	KHz	10k
3	10.000	99.999	KHz	100k
4	100.00	999.99	KHz	1M
5	1.0000	10.000	MHz	10M

Table 1: Frequency ranges

On the **TTL/CMOS** output jack there is a **CMOS** or **TTL** style signal, depending on the selection of **TTL/CMOS** button, with the same frequency as the signal outputted on **OUTPUT** jack (see section 3.1.z. for details).

### Frequency setting in EXTERNAL VCG mode.

Whether or not a DC level is applied on the **VCG/SWEEP** input jack, turning the **FREQUENCY** knob will force the unit to display the frequency value outputted on the LCD display if 0 volts is applied on **VCG/SWEEP** input jack (but only on the period that the knob is being turned). To have certain results, 0 volts must be applied on the **VCG/SWEEP** input jack.

Use **UP** and **DOWN** buttons to select the appropriate range then turn the **FREQUENCY** knob till you reach the desired frequency (see *Table1* for range's details).

Applying a DC value between 0 V and +10V will cause a frequency decrease, on a ratio between 1:1 and 1:100. Applying 0 V DC value will have no effect on the output frequency but applying a + 10.0V will decrease the output frequency 100 times.

For certain output frequencies, apply fixed DC levels on **VCG/SWEEP** jack.

Varying the positive DC level on **VCG/SWEEP** jack will cause the output frequency to sweep. The output frequency will follow the changes in DC level.

**ATTENTION:** *If the DC level applied on VCG/SWEEP jack causes the output frequency to decrease under the range limit, then output frequency will not be limited to the lowest frequency allowed in that range. It will be displayed using the current range displaying rules.*

### INTERNAL SWEEP mode frequency setting.

The value displayed on the frequency value field on the LCD display represents the instant output frequency and is updated on the LCD display every 0.1s.

Use **UP** and **DOWN** buttons to select the appropriate range of the sweep start frequency. The **FREQUENCY** knob is used to select the sweep start frequency within a range (see *Table1* for range's details).

The sweep is always done from the start frequency down to stop frequency. The start frequency is always greater than the stop frequency. The stop frequency can reach a maximum of 1:100 of start frequency (see subchapter 3.1.x for learning how to set the stop frequency). The unit reaches the stop frequency after a time, which can be set between 0.01s and 30.00s, with 0.01s resolution (see subchapter 3.1.y for learning how to set the time sweep).

Turning the **FREQUENCY** knob will force the unit to display the sweep start frequency. Each time the sweep start frequency is modified, either by pressing the **UP** or **DOWN** button or turning the **FREQUENCY** knob, the sweep will be reinitialized and the unit will start outputting from the start frequency again.

### INTERNAL SWEEP mode frequency setting.

The value displayed on the frequency value field on the LCD display represents the instant output frequency and is updated on the LCD display every 0.1s.

Use the **UP** and **DOWN** buttons to select the appropriate range of the sweep start frequency. The **FREQUENCY** knob is used to select the sweep start frequency within a range (see *Table1* for range's details).

The sweep is always done from the start frequency down to stop frequency, thus start frequency is always greater than the stop frequency. The stop frequency can reach a maximum of 1:100 of start frequency (see subchapter 3.1.x for learning how to set the stop frequency). The unit reaches the stop frequency after a time, which can be set between 0.01s and 30.00s, with 0.01s resolution (see subchapter 3.1.y for learning how to set the time sweep).

Turning the **FREQUENCY** knob will force unit to display the sweep start frequency. Each time the sweep start frequency is modified, either by pressing the **UP** or **DOWN** button or turning the **FREQUENCY** knob, the sweep will be reinitialized and unit will start outputting again from the start frequency.

**ATTENTION:** *If stop frequency is under the current lower range limit, the frequency sweep will not stop at the range limit; the instant frequencies will be displayed using the current range displaying rules.*

### 3.1.2. Level setting (except FREQCOUNTER mode).

This section describes the setting of the signal level at the main output jack, **OUTPUT** jack.

Level can be set between 10mV<sub>p-p</sub> and 10.0V<sub>p-p</sub> (on 50Ω load), using 2 ranges. Pressing -20dB button will change the level range by engaging/disengaging the -20dB attenuate on the signal path (see *Table2* for details). The -20dB LED associated with the button will light when the -20dB attenuate is engaged. Turning the **OUTPUT LEVEL** knob will change the level value within the current range.

Range	Lowest value	Highest value	Unit	Resolution	-20dB LED
1	10	1000	MV	1	Lighted
2	1.01	10.00	V	0.01	No light

Table2: Level ranges

Level is displayed on the second line of the LCD display, using a 4-digit value field, followed by the unit. The decimal point is used only for the upper range. On the right of the second line, the word "Output" will be displayed to identify that the level parameter has changed. Since the second line is used for displaying other parameters when they are modified, the unit will display the output level again automatically 7 seconds after the last parameter modification,

**Note:** *The level displayed on the LCD is considered a **LOADED** value which is the level that will appear across a 50Ω load connected to the **OUTPUT** jack. If you are connecting the output to a high impedance load, the output voltage will be twice what is entered.*

### 3.1.3. Offset setting (except FREQCOUNTER mode).

This section describes the setting of the DC level added to the signal at the main output, **OUTPUT** jack.

Offset can be set between - 5.000 V and + 5.000 V (on 50Ω load), by turning the DC OFFSET knob and using 0.001V resolution (see *Table 3*). The DC Offset LED associated to DC OFFSET knob will be lighted when the DC level added to the signal is not zero.

Range	Lowest value	Highest value	Unit	Resolution
1	- 5.000	+ 5.000	V	0.001

Table 3: Offset range

Offset is displayed on the second line of the LCD display using a sign digit and a 4-digit value field, followed by the measuring unit. On the right of the second line the word "Offset will be displayed" to identify that the offset parameter has changed. Automatically, 7 seconds after the last change of the offset value, the unit will display the output level.

**Note:**

1. *The offset voltage specified is a 50Ω **LOADED** value. This is the voltage that will appear across a 50Ω load connected to the **OUTPUT** jack. If the output is being connected to a high impedance load, the output voltage will be twice what is entered.*



2. Care must be taken when specifying an output offset voltage and level such that the output does not clip. The loaded output cannot swing higher than + 5.000 V or lower than – 5.000 V. Therefore:

$$|\text{offset voltage}| + \frac{1}{2} * V_{pp} < 5.0 \text{ V}$$

### 3.1.4. Duty cycle setting (except FREQCOUNTER mode).

This section describes the duty cycle setting of the signal outputted at the main output, **OUTPUT** jack.

Duty cycle can be set between 0% - 100%, by turning the **DUTY CYCLE** knob, using 1% resolution (see Table 4). The **DUTY CYCLE** LED associated to **DUTY CYCLE** knob will be lighted when set duty cycle differs 50%, thus the signal on main output is asymmetric.

Range	Lowest value	Highest value	Unit	Resolution
1	0	100	%	1

Table 4: Duty cycle range

Duty cycle is displayed on the second line of the LCD display, using a 3-digit value field, followed by the measuring unit. On the right of the second line, the words “Duty Cycle” will be displayed to identify that the duty cycle parameter is shown. Automatically, 7 seconds after the last change of the duty cycle value, the unit will display the output level.

### 3.1.5. CMOS level setting (except FREQCOUNTER mode).

This section describes the level setting of the **TTL/CMOS** style signal outputted at the **TTL/CMOS** output jack.

Output level at the **TTL/CMOS** jack can be fixed or adjustable, depending on the **TTL/CMOS** button. The button enables/disables the use of **CMOS LEVEL** knob.

If **CMOS LEVEL** knob is disabled, it will output a fixed level TTL style signal at 4.5V (unloaded). The TTL LED will be lit. The fixed TTL level is displayed on the second line of the LCD display using a 2-digit value field followed by the measuring unit. The words “TTL OUT” will be displayed on the right of the second line to identify that the TTL level is shown. The unit will display the output level automatically 7 seconds after the last turning of **CMOS LEVEL** knob,

If **CMOS LEVEL** knob is enabled, the CMOS output level can be set between 4.0V and 14.0V (unloaded) by turning it using 0.1V resolution (see Table 5). The CMOS LED will be lighted. The CMOS level is displayed on the second line of the LCD display using a 3-digit value field followed by the measuring unit. the words “CMOS OUT” will be displayed on the right of the second line to identify that the CMOS level is shown. The unit will automatically display the output level 7 seconds after the last turning of **CMOS LEVEL** knob.

Signal	Lowest value	Highest value	Unit	Resolution	LED lighted
TTL	4.5	4.5	V	-	TTL LED
CMOS	4.0	14.0	V	0.1	CMOS LED

Table 5: CMOS level range

Pressing this button will enable/disable the use of **CMOS LEVEL** knob. If enabled, the CMOS LED is lighted and the output level on **TTL/CMOS** output jack can be changed. If disabled, the TTL LED is lighted and there is a fixed level on **TTL/CMOS** output jack.

### 3.1.6. Sweep time setting (only for INTERNAL SWEEP mode).

This section describes the sweep time setting of the signal outputted on **OUTPUT** jack when **INTERNAL SWEEP** mode is active (INT LED and LIN/LOG LED are lighted).

Sweep time parameter represents the time needed by the unit to perform a frequency sweep between two frequencies, a start frequency and a stop frequency. Sweep time can be set between 0.01 s and 30.00 s by turning the **SWEEP TIME** knob using a 0.01s resolution (see Table 6).

Range	Lowest value	Highest value	Unit	Resolution
1	0.01	30.00	s	0.01

Table 6: Sweep time range

Sweep time parameter is displayed on the second line of the LCD display using a 4-digit value field and a decimal point, followed by the measuring unit. The words “Sweep Time” will be displayed on the right of the second line to identify that the sweep time parameter is shown. The unit will automatically display the output level 7 seconds after the last change of the sweep time value.

### 3.1.7. Sweep width setting (only for INTERNAL SWEEP mode).

This section describes the sweep width setting of the signal outputted on the **OUTPUT** jack when **INTERNAL SWEEP** mode is active (INT LED and LIN/LOG LED are lighted).

Frequency sweep is performed by changing the output frequency within a range. The start frequency is always greater than the stop frequency. The start frequency setting is performed by turning the **FREQUENCY** knob. The stop frequency represents a fraction of the start frequency; the fraction set by turning the **SWEEP WIDTH** knob. The sweep width value is not directly obtained by turning a knob; we must calculate it using the formula:

$$\text{sweep\_width} = \text{start\_frequency} * [1 - 1/(\text{value\_SWEEP\_WIDTH\_knob})] \text{ [Hz]}$$

where “value\_SWEEP\_WIDTH\_knob” represents the value set by turning the **SWEEP WIDTH** knob. The fraction of the start frequency can be set between 1 and 100 by turning **SWEEP WIDTH** knob, using 1-unit resolution (see Table 7).

Value	Stop frequency	Sweep width	Resolution	Observation
1	Start frequency	0	1	Lowest value
100	(Start frequency)/100	0.99*(start frequency)		Highest Value

Table 7: sweep width calculation

Sweep width parameter is displayed on the second line of the LCD display using a 3-digit value field and a decimal point followed by the measuring unit. The words “Sweep Width” will be displayed on the right of the second line to identify that the sweep width parameter is shown. The unit will automatically display the output level 7 seconds after the last change of the sweep width value.

### 3.1.8. Gate setting (only for FREQCOUNTER mode).

This section describes the gate period time setting used for measuring the signal frequency applied on **COUNTER IN** jack.

By pressing the range buttons, **UP and DOWN**, we can switch gate period time. There are 4 available period times for the gate: 0.01 s, 0.1 s, 1 s, and 10 s.

Gate period time is displayed on the second line of the LCD display. The mode identifier is displayed first, then the word “Counter”, followed by the value of the gate period time.

## 3.2. Mode description

### 3.2.1. EXTERNAL VCG (External Voltage Control Generator).

This mode is used for generating an output waveform whose output frequency depends on the value set using the range buttons, the **FREQUENCY** knob, and the external positive DC level applied on VCG **SWEEP/COUNTER IN** jack. The positive DC value applied on **VCG SWEEP/COUNTER IN** jack will cause the output frequency to decrease proportionally, with a ratio between 1:1 and 1:100 (for DC value between 0.0 V and +10.0 V, respectively).

#### 3.2.1.1. Selecting EXTERNAL VCG mode.

**EXT LED** lighting indicates active **EXTERNAL VCG** mode.

Otherwise there are 2 modes of selecting **EXTERNAL VCG** mode using front panel buttons depending on the current working mode and the current value of **SWEEP INT/EXT** button.

If in the **INTERNAL SWEEP** mode (**INT LED** lights), pressing the **SWEEP INT/EXT** button will engage the **EXTERNAL VCG** mode. By engaging this mode, the **EXT LED** lights, and **INT LED** stops lighting.

If in the **FREQCOUNTER** mode (**COUNTER LED** lights), pressing the **COUNTER/VCG SWEEP** button will engage the mode selected by the **SWEEP INT/EXT** button. If the button activates the **INTERNAL SWEEP**, the case will be the same as described in the previous paragraph otherwise the button will activate **EXTERNAL VCG** mode.

### 3.2.1.2. Selecting output waveform.

Pressing one of the “**WAVEFORM**” buttons: **SINE WAVE SELECT**, **SQUARE WAVE SELECT** or **TRIANGLE WAVE SELECT**, will engage one of the desired waveform: sine, square or triangle respectively. The current selected type of waveform will have their corresponding LED lighted.

The shape of the waveform can be changed by modifying the duty cycle parameter (see example from section 3.2.5.4, where there are displayed waveforms, with different duty cycle parameters).

### 3.2.1.3. Selecting the frequency.

The output frequency can be set on the **OUTPUT** jack between 0.00Hz and 10.000MHz. See section 3.1.1 for details regarding setting of the frequency value. This will also set the output frequency of the **TTL/CMOS** style signal outputted on **TTL/CMOS** jack.

To set certain frequency values it is preferable that the **VCG/SWEEP** input jack is disconnected from any source signal before pressing the range buttons or turning the **FREQUENCY** knob. This way the **VCG/SWEEP** input jack does not affect the setting of the current output frequency.

After setting the frequency using front panel controls, the selected output frequency can be modified by applying positive DC levels on the **VCG/SWEEP** input jack. The DC levels must be within [0V, 10.0V] range, causing the output frequency to decrease with a ratio of the original value with the ratio varying between 1:1 and 1:100, respectively.

**ATTENTION:** Applying in excess DC levels above +10.0 V on **VCG SWEEP** input jack can damage the input.

Applying certain positive DC levels on **VCG/SWEEP** jack will decrease the output frequency; the resulting fixed output frequency represents a fraction of the original output frequency (see example 1).

Changing the DC level in a ramp style will cause a frequency sweep on the main signal output, the **OUTPUT** jack (see example from section 3.2.5.1).

### 3.2.1.4. Selecting the level.

The signal's output level on **OUTPUT** jack can be set using the **OUTPUT LEVEL** knob between 10mV<sub>p-p</sub> and 10.0V<sub>p-p</sub> (on 50Ω load), regardless of the waveform type. See section 3.1.2 for details regarding setting of the level value (see example from section 3.2.5.1).

The -20dB LED will be lighted if the -20dB attenuation is engaged on the main signal output path.

### 3.2.1.5. Selecting the offset.

The DC level added to the output signal on **OUTPUT** jack can be set using the **DC OFFSET** knob between -5.000V and +5.000V (on 50ohm load), regardless of the waveform type. See section 3.1.3 for details regarding setting of the offset value (see example from section 3.2.5.1).

The **DC OFFSET LED** lights if the offset value is not 0.

### 3.2.1.6. Selecting the duty cycle.

The duty cycle of the output signal on the **OUTPUT** jack can be set using the **DUTY CYCLE** knob, between 0% and 100%, regardless of the waveform type. See section 3.1.4 for details regarding the setting of the offset value (see also examples 1, 2 and 3 on section 3.2.1.8).

**Attention:** *The square wave has the true meaning of duty cycle. By turning the **DUTY CYCLE** knob, the symmetry of the waveform will change for the sine wave and triangle wave. For sine wave, a distorted wave shape will be obtained and for the triangle wave, a ramp wave will be obtained.*

The **DUTY CYCLE LED** lights when output signal is asymmetric.

See section 3.2.5.5 for waveform examples.

### 3.2.1.7. Selecting output TTL/CMOS level.

The **TTL/CMOS** signal level can be changed using the **TTL/CMOS** button and **CMOS LEVEL** knob.

If CMOS output style is enabled, the output level can be set between +4.0V and +14.0V, unloaded.

See section 3.1.5 for details regarding setting of the CMOS level (see also examples 1 and 2 on section 3.2.1.8).

### 3.2.2. INTERNAL SWEEP

This mode is used for outputting a signal on the **OUTPUT** jack that sweeps a frequency range. The output frequency does not depend on any value applied on the input jack, **VCG SWEEP/COUNTER IN**.

#### 3.2.2.1. Selecting INTERNAL SWEEP mode.

**INT LED** lighting indicates active **INTERNAL SWEEP** mode.

There are 2 modes of selecting **INTERNAL SWEEP** mode using the front panel buttons depending on the current working mode and the current value of **SWEEP INT/EXT** button.

In **EXTERNAL VCG** mode (**EXT LED** lights), pressing the **SWEEP INT/EXT** button will engage the **INTERNAL SWEEP** mode. By engaging this mode, the **INT LED** lights and **EXT LED** stops lighting.

In **FREQCOUNTER** mode (**COUNTER LED** lights), pressing **COUNTER/VCG SWEEP** button will engage the mode selected by **SWEEP INT/EXT** button. If the button activates **EXTERNAL VCG**, the case is the same as described in the previous paragraph, otherwise the button will activate the **INTERNAL SWEEP** mode.

#### 3.2.2.2. Selecting output waveform.

Pressing one of the “**WAVEFORM**” buttons: **SINE WAVE**, **SELECT**, **SQUARE WAVE SELECT** or **TRIANGLE WAVE SELECT**, will engage one of the desired waveform: sine, square or triangle respectively. The current selected type of waveform will have their corresponding LED lighted.

The shape of the waveform can be changed by modifying the duty cycle parameter (see section 3.2.5.4, where there are displayed waveforms for different duty cycle parameters).

#### 3.2.2.3. Selecting the frequency.

The sweep start frequency can be set directly on the **OUTPUT** jack using the range buttons and the **FREQUENCY** knob. Sweep start frequency can be set between 0.00Hz and 10.000MHz (see section 3.1.1 for details regarding the setting of the frequency value).

The sweep stop frequency cannot be set directly. The **SWEEP WIDTH** knob must be turned in order to modify the sweep stop frequency (see sections 3.1.7 and 3.2.1.9 for details).

Modifying any sweep parameter will restart the sweep with the new loaded parameters from the start frequency. Turning the **FREQUENCY** knob will always display the sweep start frequency on LCD display (see section 3.2.5.2 for example of setting sweep start frequency).

#### 3.2.2.4. Selecting the level.

The signal's output level can be set on the **OUTPUT** jack, using the **OUTPUT LEVEL** rotary knob, between  $10\text{mV}_{\text{pp}}$  and  $10.0\text{V}_{\text{pp}}$  (on  $50\ \Omega$  load), regardless of the waveform type. See section 3.1.2 for details regarding the setting of the level value (see example from section 3.2.5.2).

The  $-20\text{dB}$  LED will be lighted if the  $-20\text{dB}$  attenuation is engaged on the main signal output path.

#### 3.2.2.5. Selecting the offset.

The DC level added to the output signal on **OUTPUT** jack can be set by using the **DC OFFSET** rotary knob between  $-5.000\text{V}$  and  $+5.000\text{V}$  (on  $50\ \Omega$  load), regardless of the waveform type. See section 3.1.3 for details regarding the setting of the offset value (see example from section 3.2.5.2).

The **DC OFFSET LED** lights if the offset value is not 0.

#### 3.2.2.6. Selecting the duty cycle.

The duty cycle of the output signal on the **OUTPUT** jack can be set by using the **DUTY CYCLE** rotary knob between 0% and 100%, regardless of the waveform type. See section 3.1.4 for details regarding setting of the offset value (see example from section 3.2.5.2).

**Attention:** *The true meaning of duty cycle applies only to the square wave. By turning the **DUTY CYCLE** knob, the symmetry of the waveform will be changed for the sine wave and triangle wave. The sine wave will cause distorted wave shapes and the triangle will cause ramp waves.*

The **DUTY CYCLE LED** lights when output signal is asymmetric.

See section 3.2.5.5 for waveform examples.

#### 3.2.2.7 Selecting output TTL/CMOS level.

You can set the level of the signal outputted on **TTL/CMOS** jack using the **TTL/CMOS** button and **CMOS LEVEL** rotary knob. This signal's frequency is the same as the signal's frequency outputted on **OUTPUT** jack.

If **CMOS** output style is enabled, the output level can be set between  $+4.0\text{V}$  and  $+14.0\text{V}$  (unloaded). See section 3.1.5 for details regarding setting of the **CMOS** level (see example from section 3.2.5.2).

#### 3.2.2.8 Selecting sweep width

The width of the frequency range sweep can be set by changing the value of a ratio. This ratio represents the ratio applied to sweep start frequency in order to determine the sweep stop frequency.

To do so turn the **SWEEP WIDTH** knob until it reaches the desired ratio. This ratio can be changed between 1:1 and 1:100. See section 3.1.7 for details regarding the sweep width setting (see also example from section 3.2.5.2).

#### 3.2.2.9 Selecting sweep time

The time of a single complete frequency range sweep can be set by turning the **SWEEP TIME** knob until the desired time is reached. The time sweep can be changed between 0.01s and 30.00s. See section 3.1.6 for details regarding the sweep time setting (see also example from section 3.2.5.2).

#### 3.2.2.10 Selecting type of sweeping

The way the output frequency is modified can be set in a linear or in a logarithmic mode by pressing the **LIN/LOG** button. This button has two associated LED's to indicate which way is active, **LIN** and **LOG LED**.

When **INTERNAL SWEEP** mode is not active, the **LIN/LOG** button action is disabled and none of the LED associated is lighted. The way the change in frequency is selected does not affect any sweep parameters.

### 3.2.3 FREQCOUNTER (Frequency Counter mode)

This mode is used for measuring the signal applied on the **VCG SWEEP/COUNTER IN** input jack. The applied signal must be from  $50\text{mV}_{\text{p-p}}$  up to  $10\text{V}_{\text{p-p}}$ . The main & **TTL/CMOS** output will output random frequencies when the frequency counter is engaged.

The unit is capable of measuring frequencies from 5 Hz to 100 MHz, using 1 Hz resolution.

**Attention:** *Applying levels in excess of above  $+10.0\text{V}_{\text{p-p}}$  on **VCG SWEEP/COUNTER IN** input jack, can damage the input.*

### 3.2.3.1 Selecting FREQCOUNTER mode

COUNTER LED lighting indicates active FREQCOUNTER mode.

Engage in FREQCOUNTER mode by pressing the COUNTER / VCG SWEEP button. The COUNTER LED will be lighted and the word "Counter" will be displayed on the second line of the LCD.

### 3.2.3.2 Selecting gate.

One of the four available gate periods can be set by using the UP and DOWN range keys. These different gate periods allow different counting precision.

See section 3.1.8 for details regarding gate period setting (see also example from section 3.2.5.3).

### 3.2.4 Saving the default loaded mode at power-up

The current working mode and its parameters can be saved on a non-volatile location. This is loaded at power-up, with the unit resuming work from this point. If the unit will be used for a certain application that requires little changes in the mode's working parameters, the workload will be eased by speeding the setting of the parameters.

By pressing the range buttons UP and DOWN twice at the same time, you can save the current working mode and its parameters.

By pressing the buttons once, the LCD display will change, and a message will appear: "Press again for saving config." indicating the action necessary for saving active configuration. Pressing the buttons once again at the same time will save the active mode and a new message will be displayed: "Configuration saved". Pressing any other button, combinations of buttons or turning knobs will exit the saving and the unit will display the previous content (i.e. before saving).again on the LCD

After a successful saving, the message "Configuration saved" will remain displayed for 3 seconds. Afterward, the unit will automatically display the previous content (i.e. before saving) on the LCD again.

**Note:** During the whole process the unit will work normally. There are no breaks or pauses in the unit function.

See example from section 3.2.5.3 of saving a working configuration, and how the LCD display must look like in the case of a successful saving.

### 3.2.5 Setting parameters examples.

#### Initial state

Suppose the unit is powered up, and the LCD displays look like Figure 2. The unit is in EXTERNAL VCG mode, symmetric triangle style waveform outputted, no signal at VCG/SWEEP input jack, output frequency set to 2.2222KHz, output level 1.01V, DC offset 0V, TTL style signal outputted on TTL /CMOS jack.

Suppose only the following LED is lighted: EXT LED, VCG SWEEP LED, TTL LED, TRIANGLE WAVE SELECT LED (see Figure 1).

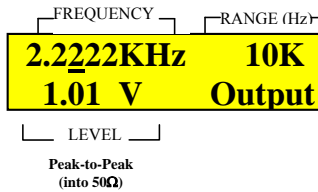

Figure 2: LCD example of using second frequency range

#### 3.2.5.1 Example of setting parameters in EXTERNAL VCG mode.

To output a sine wave signal, symmetry 65%, frequency 878KHz, level 6V<sub>p-p</sub>, DC offset -1.023 V, the CMOS output level must be set to + 8.0 V (unloaded).

#### Step 1

Press the UP button twice to reach the frequency range which is the desired frequency (see table1). The LCD display should look like Figure 3. The output frequency is now 222.22 KHz.

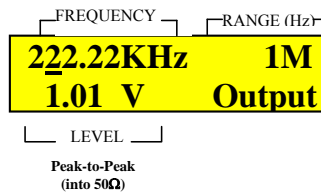

Figure 3: LCD example of using fourth frequency range

Step 2

Turn the **FREQUENCY** knob till you reach the desired frequency, 878.00 KHz. The LCD display should look like Figure 4. The output frequency is now 878 KHz.

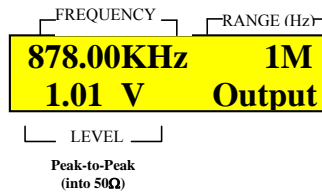

Figure 4: LCD example of using fourth frequency range

Step 3

Press the **SINE WAVE SELECT** button. The unit must output a symmetrical sine wave type signal on the **OUTPUT** jack. The **SINE WAVE SELECT LED** will light; the **TRIANGLE WAVE SELECT LED** will not light.

Step 4

Turn the **DUTY CYCLE** knob clock wise until the displayed duty cycle reaches 65%. The LCD display should look like Figure 5. The output signal on the **OUTPUT** jack should be asymmetric (an example of an asymmetric sine wave is given in section 3.2.4.3).

The **DUTY CYCLE LED** must be lighted.

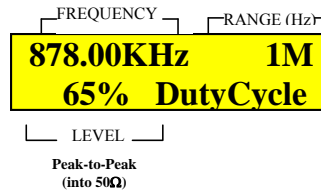

Figure 5: LCD example of displaying duty cycle parameter

Step 5

Turn the **OUTPUT** knob clockwise until the displayed output level reaches + 6.0V. The LCD display should look like Figure 6.

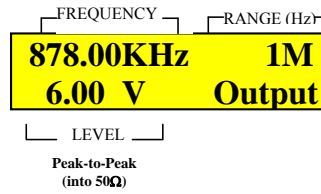

Figure 6: LCD example of displaying level

Step 6

Turn the **DC OFFSET** knob counter clockwise until the displayed output offset reaches - 1.023V. The LCD display should look like Figure 7.

The **DC OFFSET LED** must be lighted.

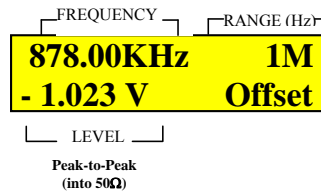

Figure 7: LCD example of displaying offset parameter

Step 7

Press the **TTL/CMOS** button. The **CMOS LED** will light; the **TTL LED** will not light. Turn the **CMOS LEVEL** knob clockwise until the **CMOS** level reaches 8.0V. The LCD display should look like Figure 8.

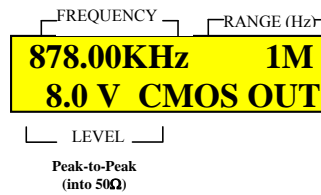

Figure 8: LCD example of displaying CMOS output level

Step 8 (automatic step performed)

The unit will display the output level parameter as shown in Figure 6, 7 seconds after the last change on the second line of LCD display.

External voltage control generator.

The current output frequency should be changed to 878 KHz by controlling the DC level applied to VCG/SWEEP input jack. Apply a DC level between + 5.0 V and + 10.0 V. The output frequency must sweep a range between 17.56 KHz and 8.78 KHz.

Illustrated below shows what will happen at the limits of the DC level range applied to the VCG/SWEEP jack.

Step 9

Apply a + 5.0 V DC level at the VCG/SWEEP jack. The output frequency will be 17.56 KHz, and the LCD display should look like Figure 9 at the start of the frequency sweep.

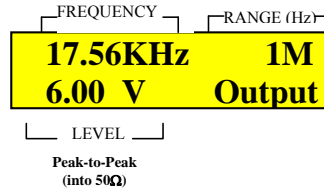

Figure 9: LCD example of displaying frequency when applying a DC level

Step 10

Change the DC level until it reaches + 10.0V. The output frequency will reach 8.78 KHz, and the LCD display should look like Figure 10 at the end of the frequency sweep.

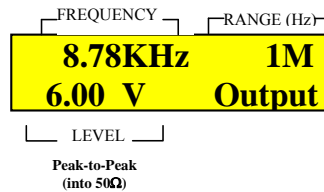

Figure 10: LCD example of displaying frequency when applying a DC level

3.2.5.2 Example of setting parameters in INTERNAL SWEEP mode.

To output a square wave signal whose frequency sweeps a 6MHz range in 21.33s, set the sweep frequency to start at 8.000MHz, symmetry 40%, level 500mV<sub>p-p</sub>, DC offset + 2.10V. Set a CMOS output level to + 4.0 V (unloaded).

Step 1

Press the UP button 3 times to reach the desired frequency range (see Table1). The LCD display should look like Figure 11. The output frequency will now be 2.2222 MHz.

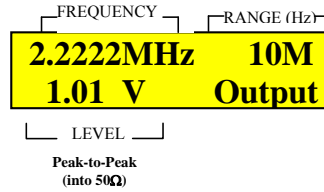

Figure 11: LCD example of using fifth frequency range

Step 2

Turn the FREQUENCY knob clockwise until you reach the desired frequency, 8.000MHz. The LCD display should look like Figure 12. The output frequency is now 8.0 MHz.

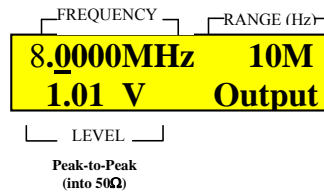

Figure 12: LCD example of using fifth frequency range



Step 3

Press the **SQUARE WAVE SELECT** button. The unit must output a symmetrical square wave type signal on the **OUTPUT** jack. As an effect of pressing the button, the **SQUARE WAVE SELECT LED** lights and the **TRIANGLE WAVE SELECT LED** is not lighted.

Step 4

Turn the **DUTY CYCLE** knob counter clock wise until the displayed duty cycle reaches 40%. The LCD display should look like Figure 13. The output signal on **OUTPUT** jack should be asymmetric (an example of an asymmetric square wave is given in section 3.2.5.3).

The **DUTY CYCLE LED** must be lighted.

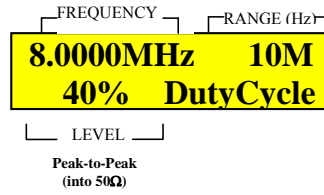

Figure 13: LCD example of displaying duty cycle parameter

Step 5

Press the **-20dB** button. This will engage the **-20dB** attenuation on the main signal path. The signal level must decrease with **-20dB**, the output level will reach a level of 101mV<sub>p-p</sub> (on 50ohm load). The LCD display should look like Figure 14.

The **-20dB LED** must be lighted.

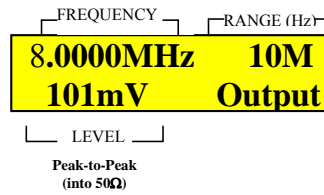

Figure 14: LCD example of using -20dB attenuation

Step 6

Turn the **OUTPUT** knob clock wise until the displayed output level reaches 500mV. The LCD display should look like Figure 15.

Output level is now 500mV<sub>p-p</sub> (on 50ohm load).

Step 7

Turn the **DC OFFSET** knob clock wise until the displayed offset level reaches + 2.100 V. The LCD display should look like Figure 16.

The **DC OFFSET LED** must be lighted.

There will be an asymmetric square wave signal of 500mV<sub>p-p</sub> (on 50ohm load), on the **OUTPUT** jack positioned at +2.100 V<sub>p-p</sub> above the zero level.

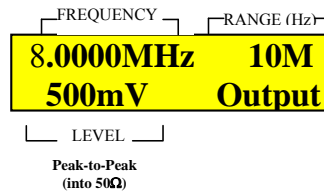

Figure 15: LCD example of using -20dB attenuation

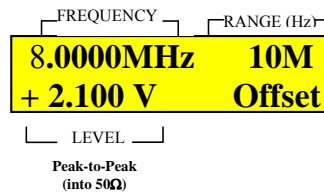

Figure 16: LCD example of displaying offset parameter

Step 8

Press the **TTL/CMOS** button. The **CMOS LED** will light and the **TTL LED** will not light. Turn the **CMOS LEVEL** knob counter clockwise until **CMOS** level reaches 4.0V. The LCD display should look like Figure 17.

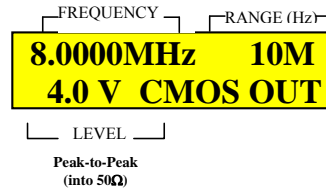

Figure 17: LCD example of displaying CMOS output level

Step 9

Press the **SWEEP INT/EXT** button. Switch the current mode to **INTERNAL SWEEP** when the **INT LED** lights.

Calculating the frequency sweep parameters.

The frequency stop frequency must be 2MHz to get a 6 MHz frequency range sweep. Using the formula given in section 3.1.7, the fraction parameter set by turning **SWEEP WIDTH** knob must be 4 because the stop frequency represents a fraction of the start frequency; the fraction set by turning the **SWEEP WIDTH** rotary knob,

Step 10

Turn **SWEEP WIDTH** knob counter clockwise until the displayed sweep width parameter reaches 4. The LCD display should look like Figure 18.

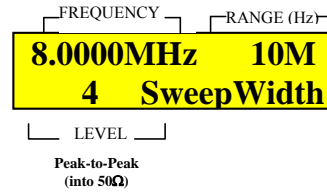

Figure 18: LCD example of displaying sweep width parameter

Step 11

Turn **SWEEP TIME** knob clock wise until the displayed sweep time parameter reaches 21.33s. The LCD display should look like Figure 19.

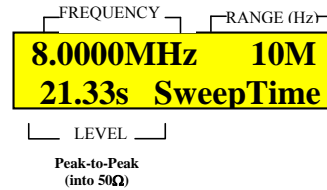

Figure 19: LCD example of displaying sweep time parameter

All the sweep parameters should be set and the asymmetric square wave signal at the **OUTPUT** jack should be sweeping a 6 MHz frequency range on 21.33s. There should be a **CMOS** type signal on the **TTL/CMOS** output jack whose frequency follows the main output signal frequency.

Step 12 (automatic step performed)

After setting all the parameters at the limits of the frequency range sweep, the LCD display must look like Figure 20, when internal sweep starts, and Figure 21, when internal sweep stops.

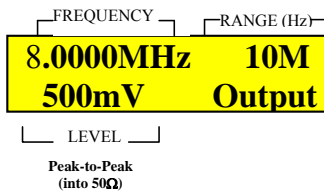

Figure 20: LCD example of sweep start frequency

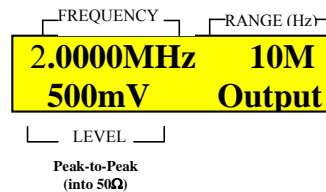

Figure 21: LCD example of sweep stop frequency

### 3.2.5.3 Example of setting gate period in FREQCOUNTER mode.

To measure the frequency of an input signal on VCG SWEEP/COUNTER IN jack, use 2 gate periods, 0.1s and 10s. Suppose the frequency of the input signal is 63,877,099Hz, the level is under 10V<sub>p-p</sub>.

Step 1

Press the COUNTER IN/VCG SWEEP button. The FREQCOUNTER mode will be engaged and the COUNTER LED will light. The rest of the LED indicating working mode, VCG SWEEP LED, INT LED and EXT LED will not light.

Using a 0.01 s gate period will be the fastest period available. At high frequencies values, there will be the highest counter error.

The content of the LCD display changes and it must look like Figure 22

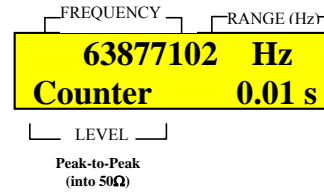

Figure 22: LCD example of displaying measured frequency using 0.01 s gate period time

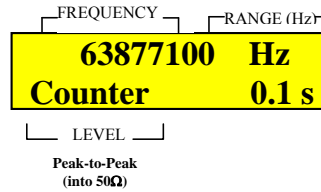

Figure 23: LCD example of displaying measured frequency using 0.01 s gate period time

Step 2

Pressing the UP button once will change the gate period to 0.1s. The gate period will decrease to 0.1s and the count will be more accurate.

The content of the LCD display will change and it must look like Figure 23.

Step 3

Pressing the UP button twice will change the gate period to 10s. The gate period will decrease to 10 s and the count will be the most accurate available.

The content of the LCD display will change and it must look like Figure 24.

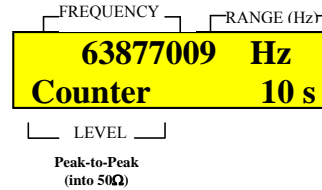

Figure 24: LCD example of displaying measured frequency using 0.01 s gate period time

### 3.2.5.4 Example of saving the active mode

This example will show the saving of the current configuration. See Figure 1 (beginning of section 3.2.), to see how the LCD display will look like before starting the saving.

Step 1

Press both the range buttons, UP and DOWN at the same time. The LCD display content will change, and it must look like Figure 25.

The unit is expecting the user to press the range buttons again at the same time.

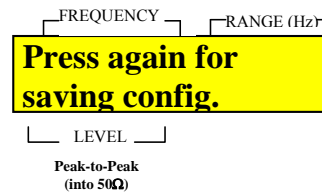

Figure 25: LCD example of displaying the initialization of saving current configuration

Step 2 (the successful case)

Press both the range buttons, **UP and DOWN** again at the same time. The current configuration will be saved and the LCD display content will change, and it must look like Figure 26, for 3 seconds.

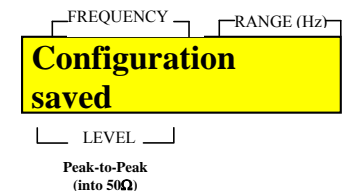

Figure 26: LCD example of displaying the success of saving current configuration

Step 2' (automatic step performed)

There are 2 ways to get this situation.

The first way is to have a successful saving.

The 2<sup>nd</sup> is to press the other button, combinations of buttons or turning knobs. The saving of configuration is abandoned.

Either way, the LCD display must look like figure 27.

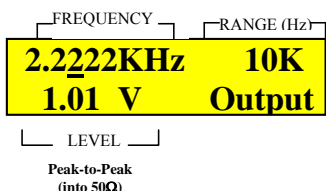

Figure 27: LCD example of displaying after a configuration saving

### 3.2.5.5 Waveform examples

This section will have examples of the outputted waveforms: sine, square, triangle for different duty cycle values.

**Attention:** *The true meaning of duty cycle applies only for the square wave. By turning the **DUTY CYCLE** knob, the symmetry of the waveform can change for sine wave and triangle wave. Therefore distorted wave shapes will be obtained for the sine wave and ramp waves will be obtained for the triangle.*

#### Sine wave type signals

Example of asymmetric sine wave, duty cycle set to 0%.

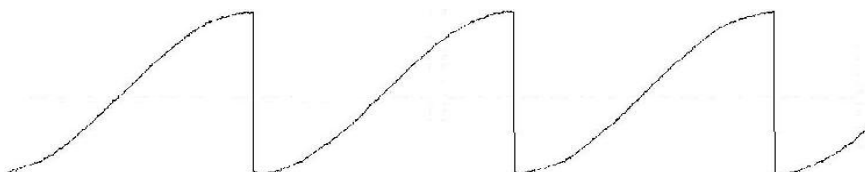

Example of asymmetric sine wave, duty cycle set to 20%.

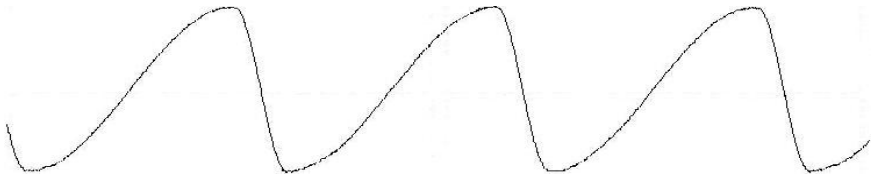

Example of symmetric sine wave, duty cycle set to 50%.

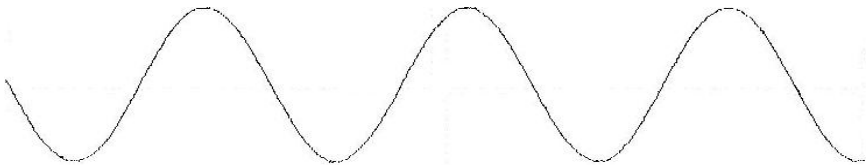

Example of asymmetric sine wave, duty cycle set to 68%.

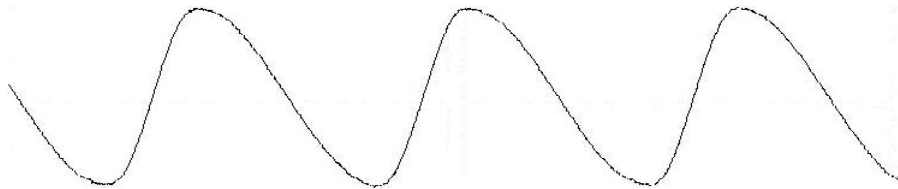

Example of asymmetric sine wave, duty cycle set to 80%.

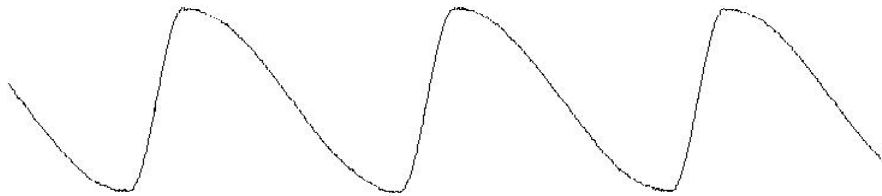

Example of asymmetric sine wave, duty cycle set to 100%.

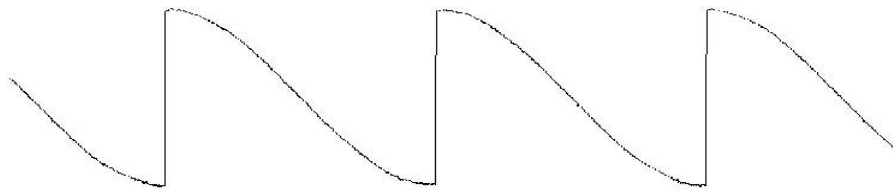

**Example of square wave type signals**

Example of asymmetric square wave (pulse wave), duty cycle set to 0%.



Example of asymmetric square wave (pulse wave), duty cycle set to 25%.

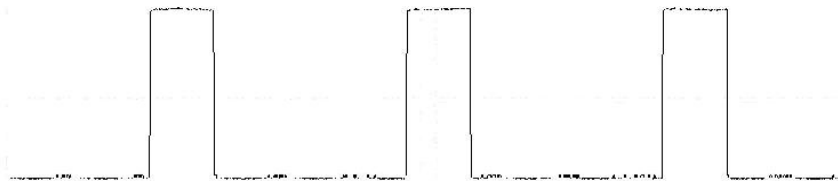

Example of symmetric square wave, duty cycle set to 50%.

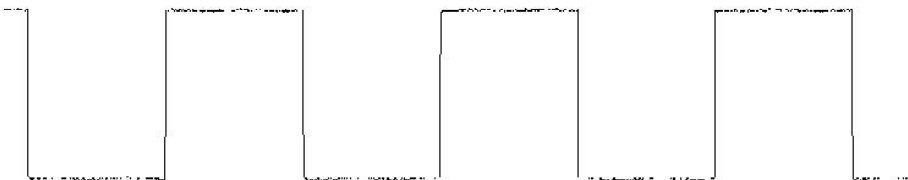

Example of asymmetric square wave (pulse), duty cycle set to 70%.

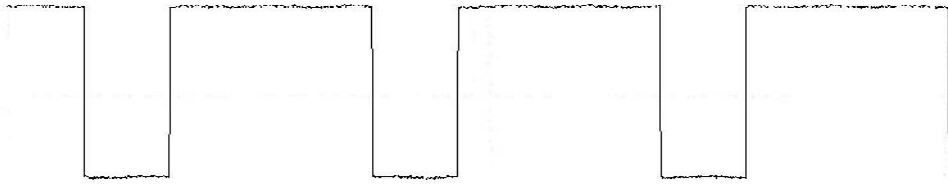

Example of asymmetric square wave (pulse), duty cycle set to 95%.



**Example of triangle (ramp) wave type signals**

Example of ramp wave (asymmetric triangle), duty cycle set to 0%.

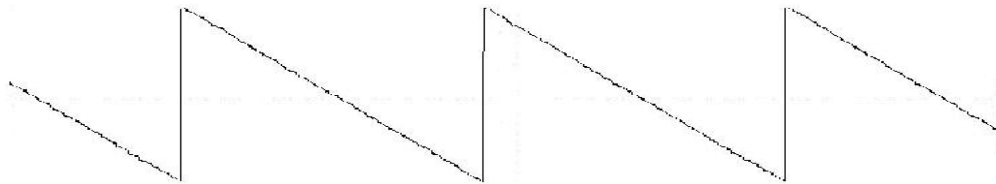

Example of ramp wave (asymmetric triangle), duty cycle set to 20%.

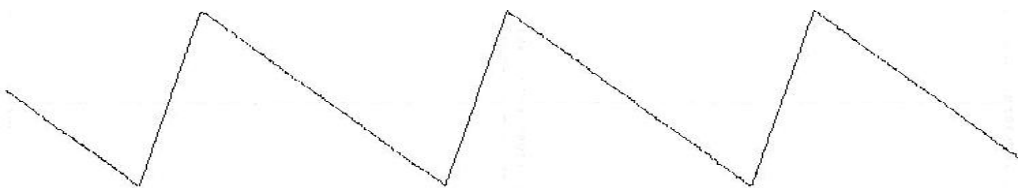

Example of symmetric triangle, duty cycle set to 50%.

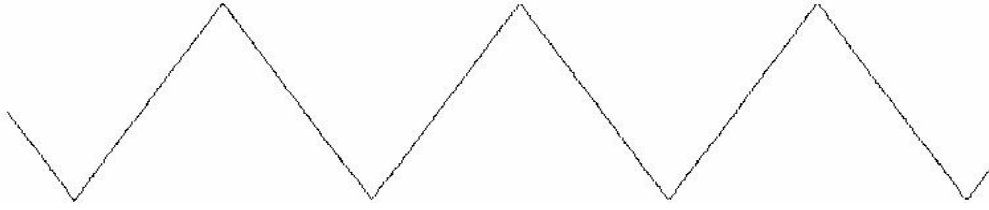

Example of ramp wave (asymmetric triangle), duty cycle set to 70%.

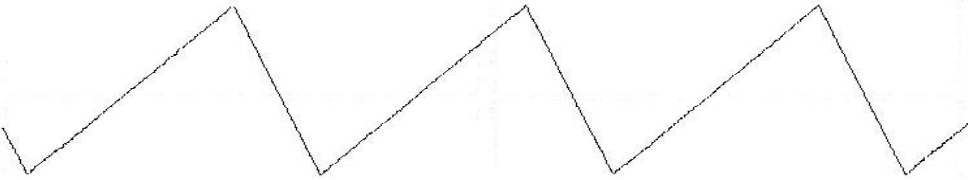

Example of ramp wave (asymmetric triangle), duty cycle set to 100%.

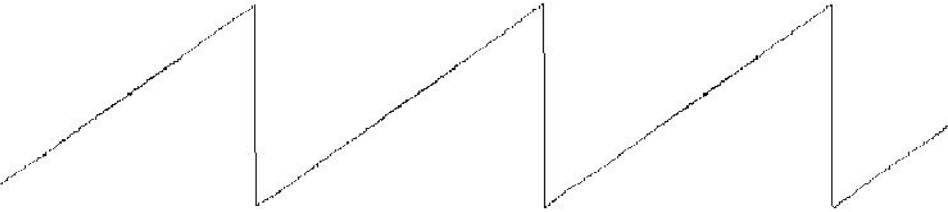



## 3.3 REMOTE mode

This is not an operating mode; it is another method of controlling the Model 4017B, through the RS232 interface. By using the **REMOTE** mode, every aspect of the unit can be controlled using a terminal without having to turn or press the front panel buttons. When **REMOTE** mode is active, the front panel controls will be disabled, and the terminal will have the full control.

**REMOTE** mode is implemented through RS232 interface by using 9600 BPS fixed communication speed, 8 data bits, 1 stop bit and no parity.

**REMOTE** mode engaged will be indicated by displaying the word "Remote" on the second line of the LCD display and by the sending of a message to the remote terminal through interface.

**REMOTE** mode disengaged will be indicated by returning the LCD display to the displaying mode without the word "Remote" on the second line of display. A message will be sent to the terminal through interface and the front panel controls will be enabled.

### 3.3.1 Brief command description.

Commands type:

- Type I: Commands for engaging/disengaging **REMOTE** mode.
- Type II: Commands for determining information regarding the unit.
- Type III: Commands for setting mode and parameters.
- Type IV: Commands for loading/saving the default mode loaded at power-up.
- Type V: Commands for aborting/forcing command execution.

For every command, the unit returns a specific message regarding the type in case of success. Failing to process a command will return specific error messages to the terminal. For full description of the commands see section 3.3.2.

*The type I command* is used for engaging and disengaging the **REMOTE** mode. Without giving the command for engaging remote mode, the unit will not accept commands of III and IV type. These commands will also enable/disable the front panel controls.

*The type II command* is used for finding information regarding the unit, i.e.: model, software version, hardware version, serial number, and whether or not unit is connected. These commands can be sent without **REMOTE** mode being active.

*The type III command* is used for a complete setting of the operating mode and its associated parameters. The implemented commands can emulate every front panel control. These commands are processed only if unit is in **REMOTE** mode.

*The type IV command* is used for saving/loading the current configuration, saved configuration on/from a non-volatile location, configuration loaded at power-up. These commands are processed only if unit is in **REMOTE** mode.

*The type V command* is used for aborting the current command execution or to force evaluation of the value sent to the unit in the case of type III command. These commands are processed even if unit is not in **REMOTE** mode.

### 3.3.2 Commands description

#### 3.3.2.1 General rules

All commands are implemented using hex ASCII characters "0" to "9" and "A" to "F". Sending other characters will abort processing, the characters received will be discarded and a specific error message will be sent to the terminal.

Characters within a command can be sent with a maximum 4-second timeout. Failing to send a character within this time will abort the process, the characters received will be discarded and a specific error message will be sent to the terminal.

There are commands that do not transfer a parameter's values and commands that send a parameter's values through interface. There are rules when you transfer values. You can send a value using a combination of a maximum 10 ASCII characters. After 10 characters are received or are exceeding the 4-second timeout, the unit will start processing the value.

The processing can be forced by issuing the character "!".

## General syntax:

XXXX[[z]yyyyyyyyyy]

These are the notations used in the syntax expression:

XXXX	Represents the main command body implemented using the hex ASCII characters “A” to “F”, “0” to “9”. Main command body can be up to 4–digit length. Commands are not case sensitive.
[z]	Parameter used only for <i>type III command</i> and represents the sign digit. Use it <i>only</i> when you have to send a sign number (i.e. offset value).
[yyyyyyyyyy]	Parameter used only for <i>type III command</i> and its value represents a maximum 10-digit value.

## Restrictions:

- Values can be sent using ASCII characters “0” to “9”, “.”, “K”, “M”. There cannot be any other characters in the 10-digit value.
- There cannot be two “.”, two “M” or two “K” in the same 10-digit value.
- Use the sign digit, “+” or “-” only for values that can be negative.
- There cannot be two sign digits or the unit will abort processing the value, the characters will be discarded and a specific error message will be sent to the terminal.

**Note:** Any command can be aborted at any sending stage, by issuing character “X”. This will abort the current command processing, previous received characters will be discarded and a specific message will be sent to the terminal.

### 3.3.2.2 Commands description.

**Type I command:** *commands used to enable/disable the REMOTE mode.*

#### RERE command

<b>Syntax:</b>	<b>RERE</b>
<b>Parameters:</b>	None
<b>Description:</b>	Enables <b>REMOTE</b> mode. On the second line of the LCD display, the “ <b>Remote</b> ” message will be displayed instead of the “ <b>Output</b> ” message. The parameters can be modified only through the RS-232 interface and the front panel will be disabled.
<b>Example:</b>	<b>RERE</b>
<b>Message returned to terminal:</b>	“ <b>Remote mode engaged</b> ”

#### RDRD command

<b>Syntax:</b>	<b>RDRD</b>
<b>Parameters:</b>	None
<b>Description:</b>	Disables <b>REMOTE</b> mode. On the second line of the LCD display, the “ <b>Output</b> ” message will be displayed instead of the “ <b>Remote</b> ” message. The parameters can be modified only through the front panel.
<b>Example:</b>	<b>RDRD</b>
<b>Message returned to terminal:</b>	“ <b>Remote mode off</b> ”.

**Type II command:** *commands used for finding information regarding the unit.*

#### **IID command**

**Syntax:** IID  
**Parameters:** None  
**Description:** Asks for the unit type connected to the interface.  
**Example:** IID  
**Message returned to terminal:** “*BK Precision Model 4017B*”

#### **IP command**

**Syntax:** IP  
**Parameters:** None  
**Description:** Asks for the presence of the unit at the terminal. Unit must return a message indicating the presence.  
**Example:** IP  
**Message returned to terminal:** “*Unit connected*”.

#### **ISV command**

**Syntax:** ISV  
**Parameters:** None  
**Description:** Asks the unit about the current soft version.  
**Example:** ISV  
**Message returned to terminal:** “*Software version: X.Y*”, where X represents the base soft version and Y represents the number of the soft version derived from the base version.

#### **IHV command**

**Syntax:** IHV  
**Parameters:** None  
**Description:** Asks the unit about the current hard version.  
**Example:** IHV  
**Message returned to terminal:** “*Hardware version: Z.W*”, where Z represents the base hard version and W represents the number of the hard version derived from the base version.

#### **IN command**

**Syntax:** **IN**

**Parameters:** None

**Description:** Sends to terminal the unit's serial number.

**Example:** **IN**

**Message returned to terminal:** *"Serial Number: XXX-YYYY-ZZZZ"* where XXX-YYYY-ZZZZ  
Represents the serial number according to BK Precision codification.

**Type III command:** *commands for setting mode and its parameters.*

### CM command

**Syntax:** **CMx**

**Parameters:** x is a 3 possible value digit: 0, 1 or 2.

**Description:** Sets the unit's working mode according to the value of the "x" parameter. If x > 2 the unit remains in the working mode and a specific error message is sent to terminal.  
If the mode is already set, any action is aborted and a specific message is sent to terminal.

**Example:** CM0 – the "EXTERNAL VCG" mode is engaged.

**Message returned to terminal:** *"Mode EXTERNAL VCG engaged"* if x = 0  
*"Mode INTERNAL SWEEP engaged"* if x = 1  
*"Mode FREQCOUNTER engaged"* if x = 2  
*"Mode unavailable"* if x > 2  
*"Mode already set"* to enable a mode which is already running.

### CF command

**Syntax:** **CFx [yyyyyyyyyy]**

**Parameters:** x represents a digit, valid for the following values: "I", "U", "D", "S".  
yyyyyyyyyy is a decimal digit value who takes values between 0 and 100000000, valid only if x = S.

**Description:** *Case 1*  
In **EXTERNAL VCG** and **INTERNAL SWEEP** mode, this command sets/modifies/interrogates the value of the start frequency.  
If x = S, the start frequency will be set at the value of the "yyyyyyyyyy" parameter which takes values between 0.00Hz and 10000000.00Hz with a 0.01HZ resolution.  
If x = U or x = D, the working domain of the "yyyyyyyyyy" parameter will be increased or respectively decreased.  
If x = I the value of the start frequency will be sent to the terminal.  
*Case 2*  
In **FREQCOUNTER** mode this command modifies the gate period used in measuring frequency or asks about the measured frequency.  
If x = U or x = D the gate period will be increased or respectively decreased.

If x = 1 the measured frequency will be sent to the terminal.

**Example:**

*Case 1*

CFS4000 – sets the start frequency at 4000 Hz.

*Case 2*

CFU – increases the gate period used in measuring frequency

**Message returned to terminal:**

*Case 1:*

“*Output frequency: yyyyyyyy,yy Hz*” if the command was correctly sent.

“*Wrong value sent*” if the “yyyyyyyyy” parameter sent was not a valid value.

*Case 2:*

“*Gate period 0.1 s*” and “*Measured frequency: yyyyyyyy Hz*” if the gate period is changed.

“*Measured frequency: yyyyyyyy Hz*” if asked about measured frequency.

**CL command**

**Syntax:**

**CLx [yyyyy]**

**Parameters:**

x represents a digit that has 2 valid values: “I” or “S”.

yyyyy is a decimal digit value between 10 and 10000, valid if x = S.

**Description:**

These commands set/interrogates the output level on the **OUTPUT** jack. The command is available only in **EXTERNAL VCG** or **INTERNAL SWEEP** mode.

If x = S the output level will be set at the value of the “yyyyy”, a level that can take values between 10mV and 10000mV.

If x = I the output level at the **OUTPUT** jack will be sent to terminal.

**Example:**

CLS345 – sets the output level at 345mV.

**Message returned to terminal:**

“*Output level: yyyyy mV*” if the command was correctly sent

“*Wrong value sent*” if “yyyyyy” parameter sent was not a valid value.

**CO command**

**Syntax:**

**COx [zyyyy]**

**Parameters:**

x represents a digit that has 2 valid values: “I” or “S”.

z is a valid digit only if x = S and has 2 valid values: “+” or “-”.

yyyy is a decimal digit value between 0 and 5000, valid if x = S.

**Description:**

This command sets/interrogates the offset level added at the **OUTPUT** jack. The command is available only in **EXTERNAL VCG** and **INTERNAL SWEEP** mode.

If x = S, the offset level will be set at the value of the “zyyyy” parameter, offset that can take values between –5000 mV and +5000 mV. It is necessary that the sign is sent first; otherwise the following parameter will be dropped.

If x = I, the offset value at the **OUTPUT** jack will be sent to the terminal.

**Example:**

COS-4333 – sets the **OUTPUT** offset level at -4333 mV.

**Message returned to terminal:**

“*Offset: zyyyy mV*” if the command is sent correctly.

“*Wrong value sent*” if “zyyyy” parameter sent was not a valid value.

## CT command

<b>Syntax:</b>	<b>CTx [yyy]</b>
<b>Parameters:</b>	x represents a digit that has only 2 valid values: "I" or "S". yyy is a decimal digit value between 40 and 140, valid if x =S.
<b>Description:</b>	The command sets/interrogates the level on <b>TTL/CMOS</b> output. The command is available only on <b>EXTERNAL VCG</b> and <b>INTERNAL SWEEP</b> mode. If x = S the CMOS output level will take values between 4.0 and 14.0 V. If x = I the CMOS level value will be sent to terminal
<b>Example:</b>	CTS123 – sets the <b>TTL/CMOS</b> output level at 12.3V
<b>Message returned to terminal:</b>	<i>"TTL/CMOS output: 12.3 V"</i> if the command is sent correctly. <i>"Wrong value sent"</i> if "yyy" parameter sent was not a valid value.

## CD command

<b>Syntax:</b>	<b>CDx[yyy]</b>
<b>Parameters:</b>	x represents a digit that has only 2 valid values: "I" or "S". yyy is a decimal digit value between 0 and 100, valid if x = S.
<b>Description:</b>	The command sets/interrogates the duty cycle of the signal output on <b>OUTPUT</b> jack. The command is available only on <b>EXTERNAL VCG</b> and <b>INTERNAL SWEEP</b> mode. If x = S, the duty cycle will take values between 0 and 100%. If x = I, the duty cycle value will be sent to the terminal.
<b>Example:</b>	CDS0 – sets the duty cycle to 0%.
<b>Message returned to terminal:</b>	<i>"Duty cycle: yyy %"</i> if the command is sent correctly. <i>"Wrong value sent"</i> if the "yyy" parameter sent was not a valid value.

## CW command

<b>Syntax:</b>	<b>CWx[yyy]</b>
<b>Parameters:</b>	x represents a digit that has only 2 valid values: "I" or "S". yyy is a decimal digit value between 1 and 100, valid if x = S.
<b>Description:</b>	The command sets/interrogates the ratio factor used to calculate the <b>STOP</b> frequency of the output signal at <b>OUTPUT</b> jack. The command is available only on <b>INTERNAL SWEEP</b> mode. If x = S the value of the ratio will take values between 1 and 100. If x = I the ratio factor used to calculate the <b>STOP</b> frequency will be sent to terminal.
<b>Example:</b>	CWS45 – sets the ratio applied to the START frequency at the value of 45.
<b>Message returned to terminal:</b>	<i>"Sweep width ratio: yyy %"</i> if the command is sent correctly. <i>"Wrong value sent"</i> if the "yyy" parameter sent was not a valid value. <i>"Command not allowed in current mode"</i> if INTERNAL SWEEP mode isn't the current working mode.

## CS command

<b>Syntax:</b>	<b>CSx [yyyy]</b>
<b>Parameters:</b>	x represents a digit that has only 2 valid values: "I" or "S".

**Description:** yyy is a decimal digit value between 1 and 3000, valid if x = S.  
 The command sets/interrogates the frequency sweep time of the output signal on the **OUTPUT** jack. The command is available only on **INTERNAL SWEEP** mode.  
 If x = S the sweep time will take values between 0.01 s and 30.00 s. If x = I the sweep time will be sent to terminal.

**Example:** CSS333 – sets the sweep time value at 3.33 s.

**Message returned to terminal:** *“Sweep time: yy.yy s”* if the command is sent correctly.  
*“Wrong value sent”* if the “yyy” parameter sent is not a valid value.  
*“Command not allowed in current mode”* if **INTERNAL SWEEP** mode isn’t the current working mode.

**CV command**

**Syntax:** CVx

**Parameters:** x represents a digit that has only 2 valid values: “0” or “1”.

**Description:** The command sets the way in which the frequency is modified during a frequency sweep. This command is available only on **INTERNAL SWEEP** mode.  
 If x=0, the linear sweep mode is engaged  
 If x=1, the logarithmic sweep mode is engaged

**Example:** CV0

**Message returned to terminal:** *“Linear sweep mode engaged”* if x=0.  
*“Logarithm sweep mode engaged”* if x=1.  
*“Unavailable command”* if x is not a valid value.  
*“Command not allowed in current mode”* if the **INTERNAL SWEEP** mode is not the current working mode.

**CE command**

**Syntax:** CEx

**Parameters:** x represents a digit who has only 3 valid values: “0”, “1”, “2”.

**Description:** The command sets the output signal type: sine, triangle or square on the main output, **OUTPUT** jack. The command is available only on **EXTERNAL VCG** and **INTERNAL SWEEP** mode.  
 If x = 0, a sine wave signal is outputted on **OUTPUT** jack.  
 If x = 1 a triangle wave is outputted on **OUTPUT** jack.  
 If x = 2 a square wave is outputted on **OUTPUT** jack.

**Example:** CE0

**Message returned to terminal:** *“Sine function generated”* if x = 0.  
*“Triangle function generated”* if x = 1.  
*“Square function generated”* if x = 2.  
*“Function not implemented”* if x digit sent was not a valid value.

## CB command

<b>Syntax:</b>	<b>CBx [y]</b>
<b>Parameters:</b>	x represents a digit that has only 2 valid values: "I" or "S". y represents a decimal digit, valid if x = S.
<b>Description:</b>	The command sets/interrogates the mode of displaying the decimals in American or French.  If x = S and y = 0, the American mode of displaying the decimals using point will be engaged.  If x = S and y = 1, the French mode of displaying the decimals using comma will be engaged.
<b>Example:</b>	CBS0 – the decimals will be displayed according to the American mode.
<b>Message returned to terminal:</b>	"LCD point display engaged (American option)" if y = 0. "LCD comma display engaged (French option)" if y = 1. "Incorrect command" if any of the digits sent was not valid.

## CG command

<b>Syntax:</b>	<b>CGx[y]</b>
<b>Parameters:</b>	x represents a digit that has only 2 valid values: "I" or "S". y represents a digit that has 2 valid values: "C" or "T", only if x = "S".
<b>Description:</b>	The command sets/interrogates the output type on <b>TTL/CMOS</b> jack.  If x = "I", the type of signal outputted on <b>TTL/CMOS</b> jack will be send to the terminal.  If x = "S" and y = "C", a <b>CMOS</b> style signal will be outputted on <b>TTL/CMOS</b> jack.  If x = "S" and y = "T", a <b>TTL</b> style signal will be outputted on <b>TTL/CMOS</b> jack.
<b>Example:</b>	CGST
<b>Message returned to terminal:</b>	"TTL signal on TTL/CMOS jack" if y = "T" "CMOS signal on TTL/CMOS jack" if y = "C" "Incorrect command" if any of the digits sent was not valid.

## CA command

<b>Syntax:</b>	<b>CAs[y]</b>
<b>Parameters:</b>	x represents a digit that has only 2 valid values: "I" or "S". y represents a digit that has 2 valid values: "E" or "D", only if x = "S".
<b>Description:</b>	The command sets/interrogates if –20dB attenuation is engaged or disengaged on the main signal output, <b>OUTPUT</b> jack.  If x = "I", a message indicating if attenuation is engaged or disengaged at signal output will be send to the terminal.  If x = "S" and y = "E", the – 20dB attenuation will be engaged on <b>OUTPUT</b> jack.  If x = "S" and y = "D", the – 20dB attenuation will be disengaged on <b>OUTPUT</b> jack.
<b>Example:</b>	CASE – will engage the – 20dB attenuation.



**Message returned to terminal:** “-20dB attenuation engaged on OUTPUT jack” if y = “E”  
“-20dB attenuation disengaged on OUTPUT jack” if y = “D”  
“Incorrect command” if any of the digits sent was not valid.

**Type IV command:** *Used for saving/loading the current configuration / saved configuration.*

### SSS command

**Syntax:** SSS  
**Parameters:** none  
**Description:** Command used to save the current working mode and its parameters as the default loaded state at power-up.  
**Example:** SSS  
**Message returned to terminal:** “*Default power-up state saved*” if the current working mode and its parameters were successfully saved.  
“*Unavailable command*” if the command sent was incomplete

### SLS command

**Syntax:** SLS  
**Parameters:** None  
**Description:** Loads the default loaded state at power-up as the current working state.  
**Example:** SLS  
**Message returned to terminal:** “*Default power-up state loaded*”  
“*Unavailable command*” if the command sent was incomplete.

**Type V command:** *used for aborting the current command execution or to force evaluation of the value sent to the unit.*

### Character “X”

**Syntax:** X  
**Description:** If the character is issued, any command pending for complete reception of characters will be aborted and the received characters are dropped.  
**Message returned to terminal:** “*Command aborted by terminal*” if the “X” character is issued.  
“*Incorrect command*” if “X” character is issued and the unit was not pending previously for full command receiving of sending it.

### Character “!”

**Syntax:** !  
**Description:** Command used to force immediate handling of the parameter value received from the terminal. Command is available only for commands that transfer values to the unit. When a parameter value has been received, the unit does not wait for a 4 second timeout in order to start value interpretation.  
**Example:** “CFS14.23!” immediately sets the frequency at 14.23 Hz.  
**Message returned to terminal:** If character “!” is issued after receiving a parameter value, the terminal will receive a message regarding the correct settings of the parameter value.  
“*Unavailable command*” or “*Wrong value sent*” are error messages sent to the terminal if “!” was issued in other conditions than those specified above.

### 3.3.3 Remote program examples

The program examples are the equivalents of the controls used in the example shown in section 3.2.5. Assume the same starting conditions: **EXTERNAL VCG** mode, symmetric triangle style waveform outputted, no signal at **VCG/SWEEP** input jack, output frequency set to 2.2222KHz, output level 1.01V, DC offset 0V, TTL style signal outputted on **TTL/CMOS** jack. Suppose only the following LED are lighted: **EXT LED, VCG SWEEP LED, TTL LED, TRIANGLE WAVE SELECT LED** (see figure 1).

#### 3.3.3.1 Example of setting parameters in EXTERNAL VCG mode using REMOTE control.

Step	Corresponding step in example from section 3.2.5.1	Issued command	Message returned
1	-	RERE	<i>Remote mode engaged</i>
2	1,2	CFS87800000	<i>Output frequency: 878000,00 Hz</i>
3	3	CE0	<i>Sine function generated</i>
4	4	CDS65	<i>Duty cycle: 65 %</i>
5	5	CLS6000	<i>Output level: 6000 mV</i>
6	6	COS-1023	<i>Offset: -1.023V</i>
7	7	CTS80	<i>TTL/CMOS output: 8.0 V</i>
8	9	CM1	<i>Output frequency: 17560,00 Hz</i>
9	10	CFI	<i>Output frequency: 8780,00 Hz</i>
10	-	RDRD	<i>Remote mode off</i>

After step 9, the LCD Display should look like Figure 28.

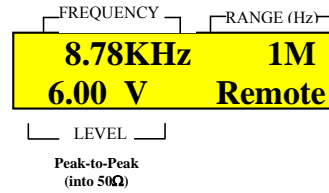

Figure 28: LCD example of displaying frequency when in REMOTE mode

3.3.3.2 Example of setting parameters in INTERNAL SWEEP mode using REMOTE control.

Step	Corresponding step in example from section 3.2.5.2	Issued command	Message returned
1	-	RERE	<i>Remote mode engaged</i>
2	1,2	CFS800000000	<i>Output frequency: 800000,00 Hz</i>
3	3	CE2	<i>Square function generated</i>
4	4	CDS40	<i>Duty cycle: 40 %</i>
5	5,6	CLS500	<i>Output level: 500 mV</i>
6	7	COS+2100	<i>Offset: +2.100 V</i>
7	8	CTS40	<i>TTL/CMOS output: 4.0 V</i>
8	9	CM1	<i>Mode INTERNAL SWEEP engaged</i>
9	10	CWS4	<i>Sweep width ratio: 4</i>
10	11	CSS2133	<i>Sweep time: 21.33 s</i>
11	-	RDRD	<i>Remote mode off</i>

After step 10, the LCD display should look like Figure 29.

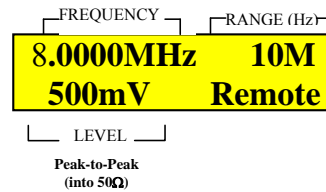

Figure 29: LCD example of sweep start frequency in REMOTE mode

3.3.3.3 Example of setting gate period in FREQCOUNTER mode using REMOTE control.

Step	Corresponding step in example from section 3.2.5.2	Issued command	Message returned
1	-	RERE	<i>Remote mode engaged</i>
2	1	CM2	<i>Mode FREQCOUNTER engaged</i>
3	2	CFU	<i>Gate period 0.1 s</i>
			<i>Measured frequency: 63877100 Hz</i>
4	3	CFU	<i>Gate period 1 s</i>
			<i>Measured frequency: 63877100 Hz</i>
5	3	CFU	<i>Gate period 10 s</i>
			<i>Measured frequency: 63877099 Hz</i>
6	-	CFI	<i>Measured frequency: 63877099 Hz</i>
7	-	RDRD	<i>Remote mode off</i>

After step 5, the LCD display should look like Figure 30.

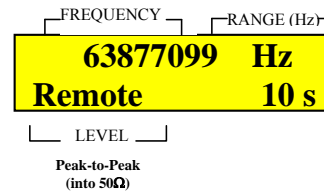

Figure 30: LCD example of displaying measured frequency in REMOTE mode

## 4. SPECIFICATIONS

### REQUENCY CHARACTERISTICS:

Waveforms:	Sine, Square, Triangle, $\pm$ Pulse, $\pm$ Ramp
Frequency:	0.01 Hz to 10MHz
Available ranges:	5
Resolution:	5 digits
Variable Duty Cycle:	0:100:1 continuously variable, 3-digit resolution
Operating Modes:	External VCG, Internal Sweep and Frequency Counter
Frequency Stability:	output will change less than 0.09% over 15 minutes after 1-hour warm-up

### OUTPUT CHARACTERISTICS:

Impedance:	$50\Omega \pm 10\%$
Output Level:	$0.01 \div 10V_{p-p}$ into $50\Omega$ $0.02 \div 20V_{p-p}$ into open circuit
Available ranges:	2
Accuracy:	$\pm 50mV_{pp}$ into $50\Omega$
Resolution:	up to 4 digits
Attenuation:	$-20dB \pm 1dB$
DC Offset:	
Preset:	$\pm 0.1V$ typical
Variable:	$\pm 10V$ into open-circuit, $\pm 5V$ into $50\Omega$
Resolution:	4 digits

### SINE WAVE:

Distortion:	$\leq 1\%$ typical at 1 kHz
Flatness:	$\pm 5\%$ (.45 dB)

### SQUARE WAVE:

Symmetry:	0.1Hz to 100 kHz $\leq 2\%$
Rise Time:	$\leq 20ns$

### TRIANGLE WAVE:

Linearity:	$\geq 98\%$ to 100kHz
------------	-----------------------

### TTL OUTPUT :

Level (aprox):	0.8V to 2.4V
Rise or Fall Time:	$\leq 25ns$ (10% to 90%)
Duty Cycle:	50% typical

### CMOS OUTPUT :

Max frequency:	10 MHz
Resolution:	3 digits
Level:	4V to 14V $\pm 0.5 V_{p-p}$ , ( 5MHz max) Continuously Variable
Rise or Fall Time ,4V:	$\leq 120ns$ (10% to 90%)

### VCG (Voltage Controlled Generator) INPUT:

Input Voltage:	0-10 $\pm 1V$ causes a 100:1 frequency change
Impedance:	$10K\Omega \pm 5\%$

### SWEEP OPERATION:

Mode:	LIN/LOG
Width:	100:1, continuously variable, 3-digit resolution
Rate:	0.01 sec to 30 sec, continuously variable, 4 digits resolution
Sweep Output:	$0.1 \div 10V_{p-p}$ into $50\Omega$

### FREQUENCY COUNTER:

Range:	5Hz to 100MHz
Accuracy:	Time base Accuracy $\pm 1$ count
Time Base Accuracy:	$\pm 10PPM$ ( $23^{\circ}C \pm 5^{\circ}C$ )
Display:	9 digits
Aging:	$\pm 5ppm/year$
Input:	$50mV_{pp}$ to $10V_{pp}$

### INTERFACE:

RS-232 using a DB-9 female connector, fix baud rate set at 9600 BPS

### POWER SOURCE:

110/220 VAC  $\pm 10\%$ , 50/60 Hz, internal jumper selectable

Included in the 4017B packaging box will be an Instruction Manual, Output BNC-to-Alligator Cable, Power Cord and protective materials including Foam Ends and a Plastic Bag.

**NOTE:** [Specifications and information are subject to change without notice. Please visit www.bkprecision.com for the most current product information.](http://www.bkprecision.com)

Field Code Changed



## 5. Service Information

**Warranty Service:** Please return the product in the original packaging with proof of purchase to the address below. Clearly state in writing the performance problem and return any leads, probes, connectors and accessories that you are using with the device.

**Non-Warranty Service:** Return the product in the original packaging to the address below. Clearly state in writing the performance problem and return any leads, probes, connectors and accessories that you are using with the device. Customers not on open account must include payment in the form of a money order or credit card. For the most current repair charges please visit [www.bkprecision.com](http://www.bkprecision.com) and click on "service/repair".

Return all merchandise to B&K Precision Corp. with pre-paid shipping. The flat-rate repair charge for Non-Warranty Service does not include return shipping. Return shipping to locations in North American is included for Warranty Service. For overnight shipments and non-North American shipping fees please contact B&K Precision Corp.

B&K Precision Corp.  
22820 Savi Ranch Parkway  
Yorba Linda, CA 92887  
[www.bkprecision.com](http://www.bkprecision.com)  
714-921-9095

**Include with the returned instrument your complete return shipping address, contact name, phone number and description of problem.**

### Limited Two-Year Warranty

B&K Precision Corp. warrants to the original purchaser that its products and the component parts thereof, will be free from defects in workmanship and materials for a period of two years from date of purchase.

B&K Precision Corp. will, without charge, repair or replace, at its option, defective product or component parts. Returned product must be accompanied by proof of the purchase date in the form of a sales receipt.

To obtain warranty coverage in the U.S.A., this product must be registered by completing a warranty registration form on [www.bkprecision.com](http://www.bkprecision.com) within fifteen (15) days of purchase.

**Exclusions: This warranty does not apply in the event of misuse or abuse of the product or as a result of unauthorized alterations or repairs. The warranty is void if the serial number is altered, defaced or removed.**

B&K Precision Corp. shall not be liable for any consequential damages, including without limitation damages resulting from loss of use. Some states do not allow limitations of incidental or consequential damages. So the above limitation or exclusion may not apply to you.

This warranty gives you specific rights and you may have other rights, which vary from state-to-state.

B&K Precision Corp.  
22820 Savi Ranch Parkway  
Yorba Linda, CA 92887  
[www.bkprecision.com](http://www.bkprecision.com)  
714-921-9095

**BK PRECISION**

**Declaration of CE Conformity**  
according to EEC directives and NF EN 45014 norm



**Responsible Party**

**Alternate Manufacturing Site**

**Manufacturer's Name:** B&K Precision Corporation

B&K Taiwan 0574

**Manufacture's Address:** 22820 Savi Ranch Pkwy.  
Yorba Linda, CA 92887-4610  
USA

**Declares that the below mentioned product**

**Product Name:** Function Generator

**Part Numbers:** 4017B

**complies with the essential requirements of the following applicable European Directives:**

Low Voltage Directive 73/23/EEC (19.02.73) amended by 93/68/EEC (22.07.93)  
Electromagnetic Compatibility (EMC) 89/336/EEC (03.05.88) amended by 92/68/EEC (22.07.93)

**and conforms with the following product standards:**

**Safety** EN 61010-1:2001

**EMC** EN 61326:1997 + A1:1998 + A2:2001  
EN 50081-1  
EN 50081-2

**This Declaration of Conformity applies to above listed products place on the EU market after:**

August 4, 2006  
**Date**

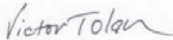
  
**Victor Tolan**  
**President**